

Girl Scouts  
Arizona Cactus – Pine Council  
Jamboree 2023

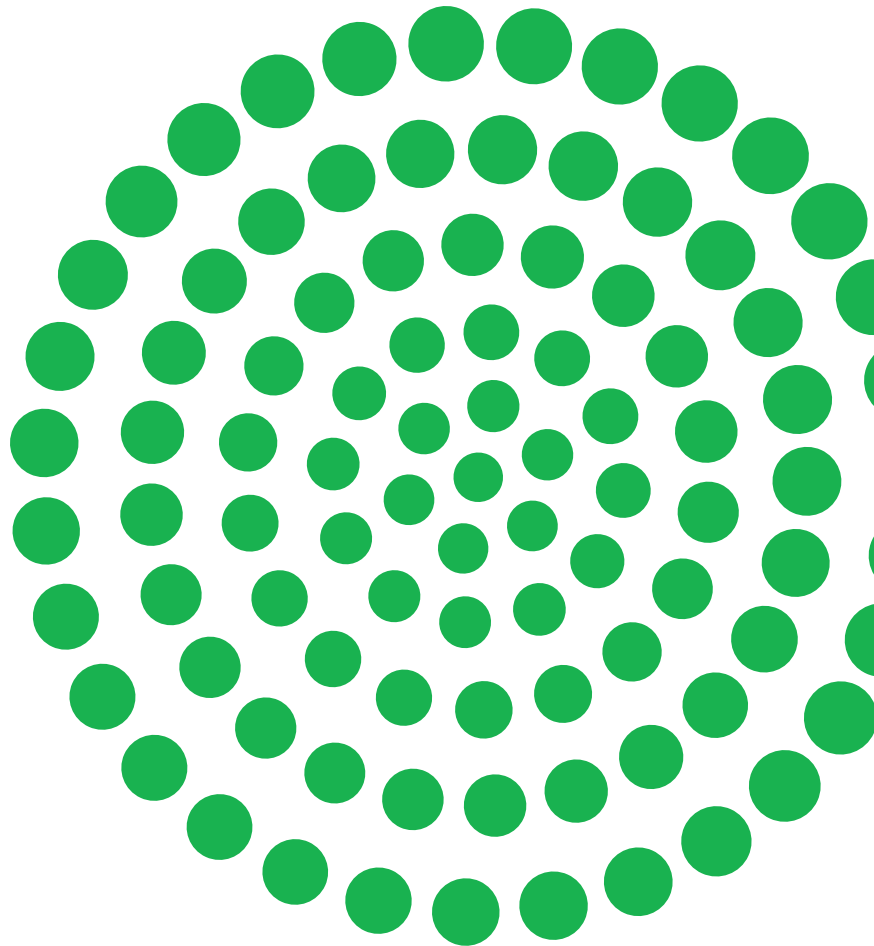

# Table of Contents

What is Jamboree?	2
Patrol Information	2
Timeline and deadlines	2
Registration	3
Arrival details	5
What to expect	6
Units	6
Site map	6
Camp details	7
FAQs	7
Camping and cabins	9
Packing list	9
Weekend breakdown/Schedule	10
Skills Challenges	10
Challenges details	10
Point structure	11
Workshops	18
Ceremony (Flag/Bridging)	20
SWAPS	20
Volunteer section	22

# Girl Scout Promise and Law

Remember to follow the Girl Scout Promise and Law. While we are all there to have fun, Jamboree can be stressful at times and tempers can run short. Be honest and fair, friendly and helpful, considerate and caring. Courtesy and cooperation go a long way towards giving everyone a positive experience!

## Girl Scout Promise

On my honor, I will try:  
To serve God and my country,  
To help people at all times,  
And to live by the Girl Scout Law.

## Girl Scout Law

I will do my best to be honest and fair,  
friendly and helpful,  
considerate and caring,  
courageous and strong,  
and responsible for what I say and do,  
and to respect myself and others,  
respect authority,  
use resources wisely,  
make the world a better place,  
and be a sister to every Girl Scout.

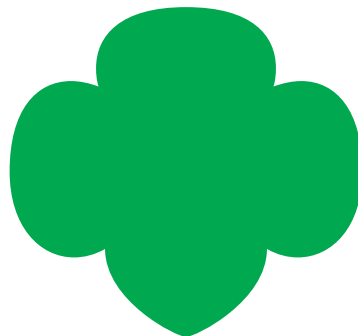
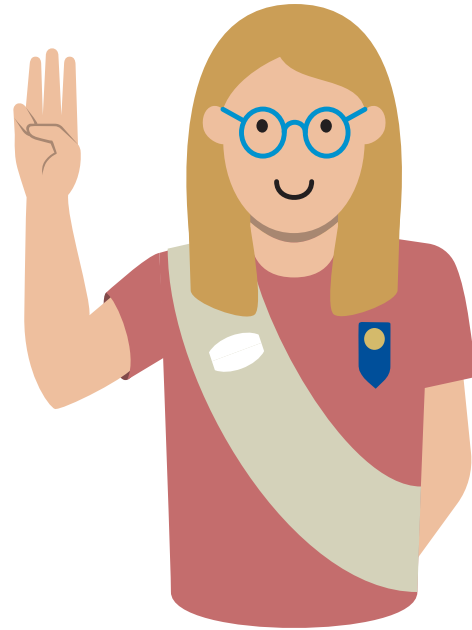

# What is Jamboree?

Jamboree is a biennial camporee for Girl Scout Juniors - Ambassadors. This event happens over the course of a three-day weekend, where Girl Scouts can enjoy tent camping, skill challenges, destination bridging, evening programming, workshops, and lots of Special Whatchamacallits Affectionately Pinned Somewhere (SWAPS)! We are excited to celebrate the outdoors and this year's theme: Time Travel! Jamboree is a great time to connect with your Girl Scout Sisters and learn new outdoor skills.

**Who:** Girl Scout Troops and IGMs (Juniors – Ambassadors)  
**Where:** Shadow Rim Ranch in Payson, Arizona  
**When:** Friday, April 28, 2023 - Sunday, April 30, 2023

**Cost:** Tent Camping - \$60 for adults and girls | Cabin Camping - \$75 for adults and girls

If you register for Cabin Camping you are required to have one adult volunteer who is willing and able to volunteer for an 8-hour period. They will not be included in your adult ratio. For both cabin and tent camping, the fees include an event t-shirt, a Jamboree fun patch, Destination bridging, skill challenge patch/rockers (if earned) and dinner on Saturday evening.

**Registration:** Opens - Jan. 9, 2023  
Closes - Mar. 1, 2023

## New at Jamboree:

- Camping areas will be closer to one another and placed in the sun. It would be a good idea to bring a canopy for your eating area.
- Bring SWAPS.
- Destination bridging will occur on Sunday morning for those that have opted in.
- There will be a sign-up for Saturday evening programming with submission guidelines.

# Patrols

Patrols are groups of 3-8 Girl Scouts that will work together during the skill challenges throughout Saturday's activities.

- Patrols sizes must be 3-8 girls that are accompanied by two unrelated adult chaperones or troop leaders.
- Patrols must be the same age levels (all Juniors). Seniors and Ambassadors may combine both age levels.

# Registration

How to Register: You can register your troop by visiting the Activities Calendar or the Jamboree webpage .

**You must submit the following forms for your registration to be complete:**

1. Health Form
2. Informational Forms and Waivers – These will be sent to participants
  - a. Volunteer Information Form – 1 per troop
  - b. Troop Information Form – 1 per troop
  - c. COVID-19 Waiver
  - d. Climbing Tower Waiver
  - e. Troop Trip Application and Approval Form
  - f. Sunday Bridging – this will be a feature when registering

**To complete your registration, have the following information available:**

- Names of all girls and adults attending
- If participating in the Sunday morning bridging, please provide the names of all girls bridging, troop number, and level they are bridging into
  - Please also include the name of the Adult Volunteer accompanying the troop/IGM
- T-shirt sizes for all girls and adults attending (adult sizes only)
- Earliest possible arrival time to camp
- Preferred adult volunteer roles
- Skill challenges your patrol(s) has/have chosen
- List of workshops in order of preference
- Any dietary restrictions

**Adult required trainings/certifications:**

- Outdoor training
  - Troop Camp Certification Level 1 (TCC1) and Level 2 (TCC2)
- First aid training

Note: All adult volunteers attending must have a cleared, current background check on file, completed through Girl Scouts-Arizona Cactus - Pine Council (GSACPC).

**Medical Records Required**

Everyone attending Jamboree needs to fill out the health form.

The forms will be available to our first aid station volunteers securely online. If a girl or an adult has a medical emergency, the medical professional will have the information they need; however, troops are still required to provide a girl/adult health history in case any medical treatment is needed.

## Adult to Girl Ratio

- The adult-to-girl ratio stated in the [Safety Activity Checkpoints](#) document must be met. A proper girl to adult ratio is required during the weekend to ensure everyone can enjoy their time and have help when needed.
- Any additional adults with your troop will be serving as an Event Volunteer for 4-6 hours at a certain point in the weekend.
- Cadette - Ambassador troops do not require an adult chaperone. Adults with those level troops will serve as Event Volunteers for 4-6 hours at some point over the weekend. If you would like to volunteer for a longer period of time, we'd love to have you! Please ensure to note the request on your Volunteer Information Form.

## Cancellation

The fee for Jamboree is non-refundable; In the case of a cancellation, notify our Customer Care Team at [reghelp@girlscoutsaz.org](mailto:reghelp@girlscoutsaz.org). If Jamboree 2023 is cancelled by GSACPC, a full refund will be issued.

# Arrival Details

Arrival times will be assigned to participants in the confirmation email.

- **Equipment and Transportation:** At home, pack all your troop's equipment into one vehicle. Personal gear may go into passenger car(s); girls will carry this gear as they walk to their unit or camp site. Troops are limited to one equipment vehicle per troop and one passenger vehicle per troop.
- **Troop Check-In:** Upon your arrival, a volunteer will check-in your troop so please make sure all drivers know your troop number. The volunteer will write down your troop number and the driver's first and last name on a piece of paper. You will tape that paper to the inside windshield once you have parked. We do this so we can contact you about any issues regarding your vehicle.
- **Drop-off Zone:** Passenger cars will drop-off passengers at the drop-off zone, then park where directed.
- **Troop Equipment Cars:** Troop equipment cars will be directed to their assigned unit or camp site to offload. When it is their turn, equipment cars will be given a color-coded unloading pass to drive to their color matching unit or camp site and drop off the troop equipment before returning to the parking lot as soon as possible (remember, there will be others waiting for the pass you have.)
  - Tip: Pack a large tarp in the equipment vehicle (on top of everything) so troop equipment can be placed onto it instead of the dirt.
- **Site Host Check-In:** The adult who gets to your unit or camp site first (either equipment car or walkers) will check-in with a site host. They will make sure you are in the correct spot. The host will also check in girls and adults by name on their list as they arrive. Be courteous to your Girl Scout Sisters by keeping your site as compact as possible, but do not despair, there will be room for all.
- **Welcome Packet:** After your site is set up, a troop leader will pick up your Welcome Packet from your site host. It contains your final event schedule, patrol schedules and scorecards, campground map, troop apparel/swag, and lanyards with name tags. If there are any errors, please inform your site host.
- If you wish to arrive early, here are a few options:
  - Volunteer to be a site host
  - Volunteer to be a parking attendant
  - Volunteer to help with set-up on Friday

Senior or Ambassador troops interested in arriving early on Friday to help with set-up can contact the Jamboree Committee at [Jamboree@girlscoutsaz.org](mailto:Jamboree@girlscoutsaz.org).

- All attendees need to arrive Friday night at the event site by 10:00 p.m. and may not leave before 9:00 a.m. on Sunday. On Sunday morning there is a Girl Scouts' Own Ceremony at the flag area at 8:30 a.m. Saturday arrivals are only for event volunteers who are not camping.

# Site Map

Shadow Rim Ranch in Payson, Arizona

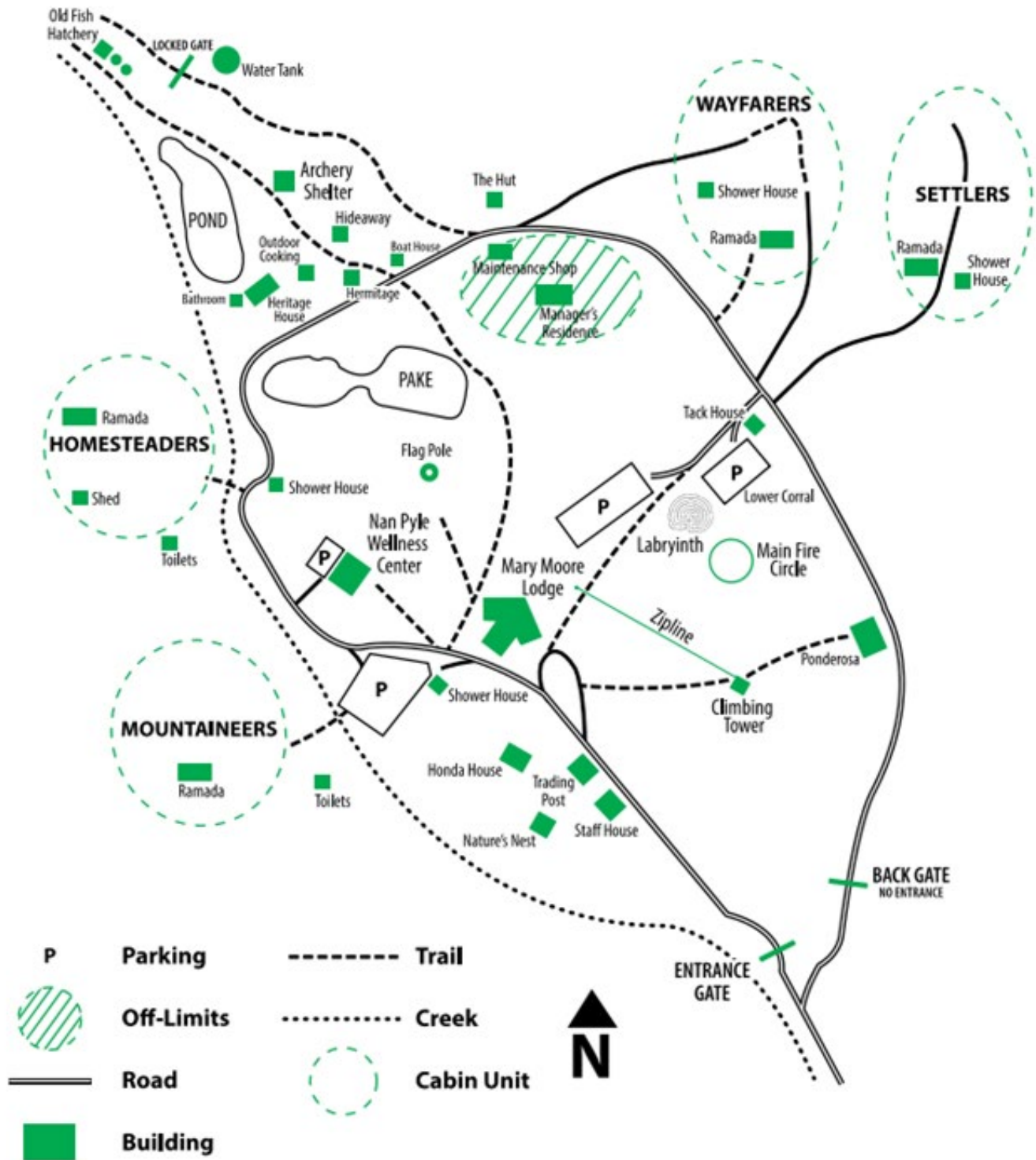



# Camp Details

## Emergencies

Emergencies will be announced by three blasts from an air horn. Meet at the flagpole located behind the lodge for further instructions.

## Speed Limit

The speed limit at the site is 5 mph. The roads are dirt so please do not drive over 5 mph. While driving please remember that the girls' safety is our top priority.

## Information Station

This window is located at the front of the lodge. It's where skill challenge score cards are turned in Saturday before 6:00 p.m.

## First Aid

The Jamboree First Aid support is at the Nan Pyle Wellness Center. First Aid personnel will be stationed there throughout the event. Please use your troop first-aider to tend to minor first aid needs. Those with more serious injuries and illnesses should come to the Wellness Center. Also, if you need First Aid and are not near your supplies, please do not hesitate to use the Wellness Center. Medications are not provided or distributed.

## Campfires

Open fires at campsites/cabin units are NOT allowed. This includes the following fires: charcoal, wood, or portable fire pits. Propane camp stoves are allowed.

## Electronic Devices

Please use electronic devices to a minimum. Cell service is very limited so be sure to get your communication needs met in town. Landlines are available onsite for emergencies. Recharging facilities are not available.

## Valuables

Make sure to label everything. Our council is not responsible for lost, stolen, or damaged items brought to Jamboree.

## Alcoholic Drinks, Smoking and Vaping

Alcoholic drinks, smoking or vaping is not permitted at camp.

## Hazards

Animals may wander through camp; be sure all food is stored in solid, animal resistant containers. Please do not feed or touch wild animals.

## Tag-Alongs and Visitors

Unregistered campers and visitors are not allowed.

## Food

- Each troop is responsible for their own meals except for Saturday's dinner.
- You're going to be busy so keep your food simple. Yogurt, bagels, cream cheese, muffins, instant oatmeal, or fruit all work great for breakfasts; sandwiches work great for lunches. Friday dinner could be a bag dinner from home, or you can eat on the way. Bring snacks for the whole weekend, such as fruit, cookies, or trail mix. Keep dish washing to a minimum by using paper plates or napkins.
- Have a camp stove to keep water hot for coffee, tea, or hot chocolate.

## Attire

Girl Scouts has a dress code for camping. Girls and adults must wear closed-toe, closed-heel shoes with socks. A hat with a brim and sunscreen is strongly recommended. If you are not appropriately dressed, you will be asked to return to your campsite to change.

## Water

Troops will need to make sure everyone stays hydrated all weekend. Devise a way to carry water bottles all day. All spigots and sinks have potable water.

- Please use reusable water bottles labeled with the person's name and troop number.
- Set up and use a wash station at your campsite for washing dishes. We ask that troops use paper goods as much as possible to minimize water usage.
- Water spigots should never be left running at any time.

## Bathrooms

Unit bath houses are located throughout Camp. Portable toilets are also located conveniently throughout the campground.

- For the portable toilets to remain functional and pleasant throughout the weekend, remember to throw only toilet tissue into the toilets.
- Dispose of used feminine products into the trash, NOT the port-a-potties.
- It is our responsibility to keep the portable toilets tidy. Please be considerate of others when utilizing the restroom facilities.

## Showers

Showers are NOT to be used during Jamboree to conserve water and prevent backup in our septic system. Encourage your campers to clean up with a lite sponge bath and frequent hand washing.

## Quiet time

Lights out/quiet time is from 10:00 p.m. to 7:00 a.m.

- Remember the Girl Scout Law and be considerate and caring of one another. Everyone who visits a portable toilet during these hours should remember to close the door carefully so that it does not bang shut.

## Male Volunteers

Men 18 years or older are valued Girl Scout volunteers. Whether a troop co-leader, chaperone, troop outdoor-trained person, troop first aider, and/or an event volunteer, Girl Scout policy states men may only share tents with family members or other men. Men must not place their tents between the girls and the bathrooms.

# Cabin Camping

## Trash

Each Unit is responsible for their trash.

- Bring trash bags to use at your campsite. Trash cans are provided.
- Dispose of your trash bags in the dumpsters located throughout camp.
- Do not leave trash bags with trash in them in camp. The critters will get into them and make a huge mess for the troop to clean up.
- Remember to leave the camp cleaner than you found it!

Each troop is responsible for disposing their own trash.

- Bring trash bags to use at your campsite. Trash cans are not provided.
- Dispose of your trash bags in the dumpsters located throughout camp.
- Do not leave trash bags with trash in them in camp. The critters will get into them and make a huge mess for the troop to clean up.
- Remember to leave the camp cleaner than you found it!

## Tent Camping

- This is a semi-primitive camping area so bring a table, something to sit on, and a hand-washing set-up. You might find it useful to bring a sunshade and a wagon.
- If you do Skill Challenges, there will be other items to bring depending on the Challenge. As you read the Challenge information, you will learn what you might need to bring.
- Your final confirmation will include a Troop Equipment List and a Personal Equipment List.

# Weekend Breakdown/Schedule

## Skill Challenges

### Skill Challenge Information

A troop may participate in several ways at Jamboree. They may do skill challenges, workshops, or a perfect blend of both. If this is your first time attending, selecting a few challenges may be the best way to experience this fun event.

How to prepare for skill challenges ahead of Jamboree :

- ❑ Step 1: As a troop, review the choices of Skill Challenges being offered at Jamboree for your age level in advance. Explore the general skills for each challenge that will be learned.
- ❑ Step 2: Determine which challenges your troop members may want to try.
- ❑ Step 3: Begin to learn the skills necessary for each skill challenge in a general way. The purpose of this step is to “test out” if you like learning that specific skill set. A good way to do this is review the Video Skills located on the GSACPC website. Note: These Skill Challenges can apply to our council’s Get Outdoor Challenge!
- ❑ Step 4: Next divide your troop into patrol groups. Patrols sizes must be between 3-8 girls and be accompanied by two unrelated (non-parent/family member) adult chaperones or troop leaders. When dividing girls into patrols, their preferred challenges and ability to work as a team should be taken into consideration. The girls in the patrol **MUST** be the same age level (e.g. all Juniors). Senior and Ambassador girls may combine both age levels and be comprised of 3-8 girls.
- ❑ Step 5: Once the patrols have been formed, have a final vote on which challenges your patrol would like to sign up for. If your troop has several patrols, each can choose their own line-up of challenges.
- ❑ Step 6: Have your leader submit the Troop Information Form with your challenge choices no later than Mar. 1, 2023. Please be aware that this is also the deadline to drop a challenge.
- ❑ Step 7: Continue to train and practice for each skill challenge your patrol has signed up for.

As the date draws closer, a patrol may decide not to participate in a challenge which they originally registered for. Challenges can be dropped by e-mailing [Jamboree@girlscoutsaz.org](mailto:Jamboree@girlscoutsaz.org) no later than **Mar. 1, 2023**. Patrols are expected to follow through and show up to every skill challenge for which they registered.

Patrols and Score Cards:

- ❑ Each patrol receives a score card in their Welcome Packet at check-in with your village host. Write the names of the girls in the patrol on the back of the card. Note in the provided box if you have any girls with disabilities or special needs. Your patrol will give this score card to the skill evaluator at each skill challenge. The patrol will get it back at the conclusion of each challenge. The patrol is responsible for the safe-keeping of their score card.

In order to have your scores tallied, the score card **MUST** be turned in to the Information Window no later than 6:00 p.m. Saturday.

- Patrols should make every effort to arrive at a challenge at their scheduled time. By doing so it shows respect to our volunteers and helps the event run smoothly for everyone.
- Patrols must stay together, and girls cannot change patrols once assigned.
- During a skill challenge, adults are encouraged to bring a chair, sit back, and watch their patrols go to work. Adults and non-participating girls are not allowed to hover, help, or coach the patrol while they are working. This is your girls' time – let them shine on their own! Look for a special audience area at each challenge to observe.
- Photos (if allowed by the lead skill challenge judge) may ONLY be taken after the challenge is over.

Skill Challenge	Length of Time ( <i>Minutes</i> )	Junior ( <i>Points</i> )	Cadette ( <i>Points</i> )	SR/AMD ( <i>Points</i> )
Fire Building	30	100	100	100
Lashing	60	100	100	100
Orienteering	60	100	100	100
Shelter Building	60	100	100	100

The objective of each skill challenge is for your patrol to apply a new outdoor skill while building teambuilding skills. Challenges are not competitions, rather each patrol should strive to do their best. The completion of each skill challenge is measured against a set standard within the following categories:

- Skill-based components
- Teamwork
- Quality of skill
- Completion of activity

Points accumulated during each skill challenge will determine each patrol's ranking. Each Girl Scout will receive a patch and rocker when she completes and passes a skill challenge.

Point Ranking System	Levels
1-100	1
101-200	2
201-300	3
301-400	4
401+ Bonus	5

# Fire Building Challenge



Age Level: All  
Points: 100  
Time Allowed: 30 min



## Requirements:

Patrols will demonstrate the ability to successfully build, light, and maintain a fire to boil the water in a metal pot. There will be a grill/grate for the pot to sit on. Patrols may use more than one match if needed. The fire must stay lit for a minimum of five minutes or until the water comes to a rolling boil (with bubbles at least 1/4" in diameter breaking the surface of the water faster than can be counted). Be punctual and ready to go. Your 30 minutes at this challenge includes time to prepare the area, lay the fire, light it, boil the water, douse the fire, and clean up.

Patrols are expected to demonstrate the following skills:

- Safety: Each girl should have her hair tied back and/or up to keep it out of the fire. Nothing should dangle on the outside of their clothing. Girls should also be cautious of clothing being a fire hazard, especially if it is baggy or made of nylon.
- Building, lighting, and maintaining the fire
- Length of time to boil water (up to 10 minutes)
- Extinguishing the fire and cleaning up the site
- Teamwork: While safety is a priority and completing the task is the goal, teamwork and cooperation are key.

Above and Beyond for Juniors and Cadettes: Patrols will earn bonus points for a “one-match fire” (using only one match to successfully light the fire).

Above and Beyond for Seniors/Ambassadors: Patrols will earn bonus points if they are able to successfully light a matchless fire using steel with either flint, ferrocerium, or magnesium. You will need to bring this with you.

What to Expect: Your patrol will be assigned to a Skill Evaluator and a location to work. When you are ready to strike your first match, let the Skill Evaluator know and they will start the timer. The goal is to keep the fire going until your water comes to a rolling boil (max. time: 10 min.). At the end of the challenge, you will be expected to extinguish your fire correctly and clean up your site.

## Find Out More:

- When working with fire, safety is always the first thing to learn. Review fire safety rules, how to build a fire, what it needs to burn, and how to extinguish it in your TCC2 Handbook.
- You can also study the GSUSA book *Outdoor Education in Girl Scouting*. Look in the book's index under Wood Fires for additional information.

## Materials:

- Materials provided: kindling, tinder, wood, water, pot, grill/grate, matches, trowel (clean up), oil pan (safe space for lighting a fire)
- Materials not provided: If you are planning to use an alternate lighting method for bonus points (Senior/Ambassador), you will need to supply that.

## Things to Remember When Practicing:

- Tip: Log cabin or A-frame style fires work best for this challenge.
- Wood: Very dry, cured pine is a good type of wood to use. You do not need logs for this challenge; small kindling and tinder are better. All materials burned in the fire must be natural and contain no accelerants either natural or man-made. Example of materials that are good to use include: animal bedding shavings, small twigs, sticks, and pieces of wood. Examples of materials that are not acceptable due to accelerants in them are: pitch pine (or fat wood, a wood that has a natural accelerant in it), or wood soaked in lighter fluid. Also not allowed are paper, cotton balls, dryer lint, wax, etc.
- Amount of Kindling/Tinder: Typically, about two to three baseball caps full of kindling and one of tinder is enough to get the water to a rolling boil.

# Lashing Challenge

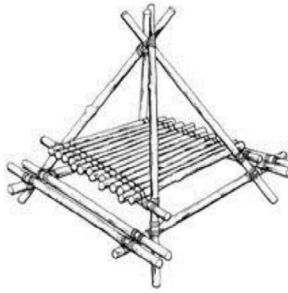

Age Level: All  
Points: 100  
Time Allowed: 60 min

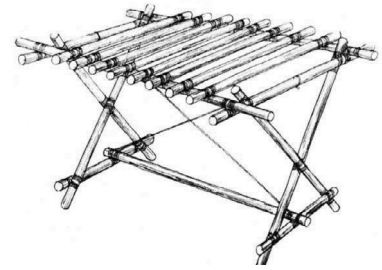

## Requirements:

Your patrol will check in and then draw your first card with a project listed. You will then get to work constructing your lashing project. Once it is complete and approved by the judge, you may draw your second card and begin building. These projects must be completed within the hour. If you have time left over, you can build a third project for bonus points (see Above and Beyond).

Your planned project must meet these criteria:

- Use at least three (3) different methods of lashing; four (4) methods for Cadettes./Seniors / Ambassadors.
- Use a minimum of 10 pieces of wood/poles (except for the tripod table, flagpole, and bonus projects).
- Must stand on its own and cannot utilize stakes that are pounded into the ground.
- Projects your patrol needs to know how to build:
  - Juniors - Simple Table (top right photo), tripod table, drying rack (See photos below)
  - Cadettes/Seniors/Ambassadors - sitting table (top left photo), chair, drying rack, flagpole (See photos below)

The skill evaluator for this challenge will be looking at teamwork, correctness of knots used, and your wrapping and frapping techniques throughout the building process. Each girl in your patrol must do part of the lashing. When you are all finished, let the skill evaluator know, and they will inspect each of your lashes for neatness and strength. Then, they will evaluate the overall sturdiness and creativity of your completed project.

## Above and Beyond:

- Bonus points can be earned by building an additional project:
- J = Watering Station, CSA = three-legged trash holder



## Find Out More:

- The first step is to learn how to lash . To see this demonstrated, check out the video on the Jamboree webpage.
- Check out the following lashing methods: square, round, tripod, diagonal, sheer, continuous.

## We Will Provide:

- Pieces of wood/poles, ropes, water jug, trash bag, flag

## Lashing Samples:

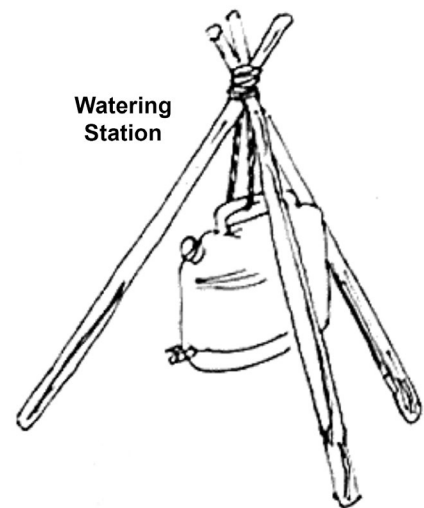
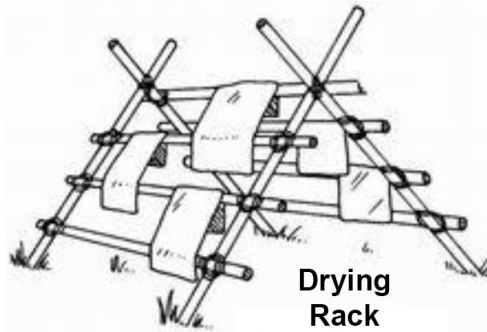
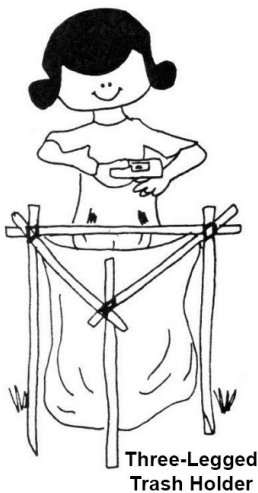
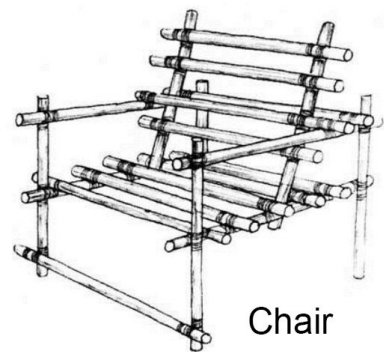
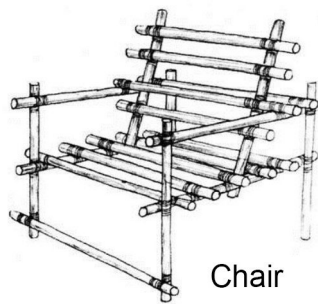
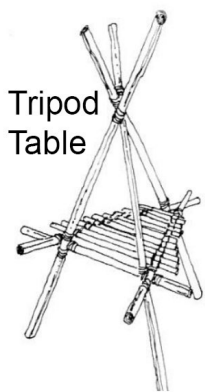

# Shelter Building Challenge

Age Level: All  
Points: 100  
Time Allowed: 60 min

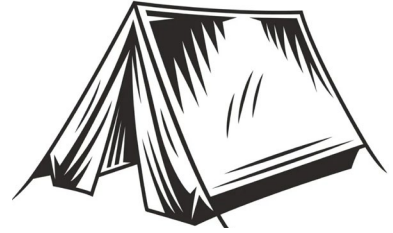

## Requirements:

Patrols will demonstrate the ability to successfully build multiple shelter types. When arriving, the patrols will draw a card with a shelter description and/or purpose on it. The patrol will then determine the shelter type being described and will start building their shelter immediately. Once complete, the judge will be notified. The judge will then determine if the correct shelter has been identified and if it has been built correctly. If so, the patrol will draw their next card. Juniors will be required to build two shelters. Cadettes, Seniors, and Ambassadors will be required to build 3.

Patrols are expected to demonstrate the following skills:

- Identify types of shelters by use and/or purpose.
- Build the shelters correctly.
- Teamwork and cooperation are key. Every person in the patrol should be actively participating.

## Types of Shelters to Know:

- Juniors - lean to, a-frame, plow point, diamond
- Cadettes/Seniors/Ambassadors - lean-to, a-frame, plow point, diamond, mini mid

Above and Beyond: Patrols will earn bonus points for building an additional shelter that they have not already built during their hour. This will be done after building the required amount and must be completed within the hour. They can choose from any listed above or any of the following: stealth, half cone fly, tipi, tarp tent, body bag, or c-fly wedge

## Find Out More:

- Explore the following sites for photos, descriptions, and uses.
  - [greenbelly.co/pages/best-ultralight-tarp-shelters-and-configurations#tsc](http://greenbelly.co/pages/best-ultralight-tarp-shelters-and-configurations#tsc)
  - [themanual.com/outdoors/how-to-build-tarp-shelters/](http://themanual.com/outdoors/how-to-build-tarp-shelters/)

## We Will Provide:

- Tarps, rope, poles, stakes

# Orienteering Challenge



Age Level: All  
Points: 100  
Time Allowed: 60 min

## Requirements:

Patrols will demonstrate the ability to successfully navigate around several controls marked on a specially drawn map. Scores will be determined by picking the most efficient route to locate as many markers as possible within your time limit. When arriving, each patrol will first play a game to show that they can accurately identify the cardinal and intercardinal directions on a compass. This will be the first way to earn points. When this is completed, patrols will receive a map of Shadow Rim, compass, control description sheet, and pencil. They will then begin their journey around camp to find the markers listed on their control sheet. They must return by the end of their session or points will be deducted for every five minutes that they are late. Patrols will not have time to find all of the markers on the control description sheet. Instead, they will earn points for each control that they can correctly mark on their sheet. There will be two letters on each marker. Control description sheet will be turned in and checked by the judge for scoring.

Patrols are expected to demonstrate the following skills:

- Use the following techniques: cardinal and intercardinal direction identification, map reading, compass navigation, pace counting, map symbol identification, and CAR (control, attack point, & route).
- Navigate through Shadow Rim to identify as many markers as possible in a score-o type challenge.
- Stay together as a patrol when moving from marker to marker. Patrols may not split up.
- Teamwork and cooperation are key. Every person in the patrol should be actively participating.

## Find Out More:

- The Introduction to Orienteering Manual is available on the Jamboree webpage.
- Explore the orienteering course at Parson's Leadership Center. The manual can be downloaded on the Jamboree webpage.

## We Will Provide:

- Compass, pencil, Shadow Rim map, and control description sheet.

# Saturday Workshops

## Workshops

The Essentials -- Workshops are also a large part of the Saturday activities.

The Details --

- There are five types of workshops offered: craft, skills, cooking, songs, and games.
- Troops that do not sign up for any skill challenges will have the option of participating in a workshop.
- Troops doing some but not all the skill challenges will get as many workshops as possible plus free time.
- You may join the songs and/or games workshops anytime as long as there is room.

## Saturday Evening Program

Can we get a.... Lights! Camera! Action! Are you ready for a performance adventure?! Then the Saturday Evening Program is the place for you!

We would love for your troop to send in your skit, song, dance, or performance. We will try our best to fit in as many as possible.

### **Important Notes:**

- Keep in mind there are 250 people in the audience.
- Skits will not be added during the Jamboree event.

### **Submission Guidelines**

Preferred submission form: email a link to an \*unlisted\* YouTube video (unlisted means you need to have the link to see the video) OR email MPEG format as an attachment.

Alternate submission form: DVD/CD by mail – address supplied once your information is received via e-mail. All emails to [Jamboree@girlscoutsaz.org](mailto:Jamboree@girlscoutsaz.org)

Deadline: Mar. 13, 2023

### **Include:**

- Leader's name for contact/coordination
- Phone number
- Troop number
- Age level
- Number of girls participating
- E-mail address

All above information must be included for your submission to be complete.

If you have any questions, please contact [Jamboree@girlscoutsaz.org](mailto:Jamboree@girlscoutsaz.org)

Still interested, but don't know what to do for a skit? Here are some ideas:

- Skits about Girl Scouts in the outdoors
- Reenact some of your favorite moments
- Classic skits based on ones you have seen at camps before.
- Perform a camp song or re-write a popular song about Jamboree and add some fun dance moves along with it!

# Flag /Ceremonies

Do you want to perform a flag ceremony or lead a Girl Scout's Own ceremony? Flag ceremonies are done Saturday morning and evening; Girl Scout's Own ceremony is happening Sunday morning. A Girl Scout's Own ceremony is a Girl Scout tradition that is short (~5 minutes) and is typically reflective of the experience that you have had. Your troop could pick a theme for the ceremony, read poetry, offer reflection, sing, or whatever they feel is appropriate. Please email [Jamboree@girlscoutsaz.org](mailto:Jamboree@girlscoutsaz.org) by Mar. 1, 2023, if interested in either of these ceremonies.

# Bridging

Bridging is a beloved Girl Scout tradition that honors girls' achievements throughout the year and celebrates their "crossing the bridge" to the next Girl Scout level. This year, we will be hosting a multi-level Bridging ceremony for all Jamboree attendees who wish to participate. While the Girl Scouts will not officially move to the next level until they start their new school year, this is a wonderful way to celebrate their achievements at our memorable 2023 Jamboree! Girl Scouts will receive their Bridging Arcs and a patch to remember their Jamboree bridging experience.

# SWAPS

SWAPS stand for "Special Whatchamacallits Affectionately Pinned Somewhere." They are small tokens of friendship that Girl Scouts exchange with one another, and each SWAP uniquely reflects a fellow Girl Scout, their troop, or a memory of a special event. This crafting booth will allow Girl Scouts to explore their creative spirits and create SWAPS to give to their fellow Girl Scout Sisters. Your troops are also welcomed to bring SWAPS to exchange at the event.

SWAPS should be:

- Handmade
- An inch or two in size
- Inexpensive – consider recycled or donated materials
- Have a pin or some way of being attached to a hat, shirt, ribbon, etc.
- Have the giver's first name, troop number, and city on it or on an attached tag.
- Reflect something about the giver or the event theme.

50 to 100 SWAPS per girl is the suggested number to make. Keep them in a zippered plastic bag for accessibility and safe keeping.

Girls should:

- Always accept a SWAP.
- Take pride in how well made her SWAPS are.
- "Do a good deed" and give a SWAP to a girl who has run out of SWAPS.
- Always say "thank you" with a smile.

# Weekend Schedule - TENTATIVE

Final revised schedules will be provided during Jamboree check-in.

## Friday

3:00 p.m.	10:00 p.m.	Troops arrive, set up camp, and check-in with village hosts.
8:00 p.m.	9:00 p.m.	Meeting for event volunteers if indicated by the lead from your area
7:30 p.m.	9:30 p.m.	TBD
10:30 p.m.	7:00 a.m. Sat.	Lights out and quiet time.

## Saturday

7:00 a.m.	8:00 a.m.	Breakfast at your campsite
8:00 a.m.		Morning skill challenge and workshop event volunteers report to stations.
8:15 a.m.	8:45 a.m.	All-camp flag ceremony and announcements
9:00 a.m.	12:00 noon	Morning rotations
12:00 noon	1:30 p.m.	Lunch break
1:00 p.m.		Afternoon skill challenge and workshop event volunteers report to stations
1:30 p.m.	5:30 p.m.	Afternoon rotations
5:30 p.m.	6:00 p.m.	All-camp flag ceremony and announcements
6:00 p.m.	7:00 p.m.	Saturday evening dinner
6:00 p.m.		Last chance - turn in skill challenge score cards!
7:30 p.m.	9:15 p.m.	Saturday evening program
9:15 p.m.	10:15 p.m.	Troop evening reflections
10:30 p.m.	7:30 a.m. Sun.	Lights out and quiet time

## Sunday

7:30 a.m.	8:00a.m.	Breakfast, pick up skill level patches from (information window)
8:00 a.m.	8:30 a.m.	Clean up, troop time. Bridging volunteers set-up
8:30 a.m.	8:45 a.m.	All-camp Girl Scouts' Own, Announcements
8:45 a.m.		Host begins passing out color-coded loading passes to allow the equipment vehicle into camp
9:00 a.m. 10:30 a.m.		All that have signed up for Bridging Ceremony meet and begin to bridge
10:30am	12:00pm	Lunch, check out with host, and have a great ride home!

Volunteers make Jamboree a memorable experience. Jamboree would not be possible without the support of Volunteers; we are sincerely grateful for your help!

Every troop adult, including leaders, must fill out a Volunteer Information Form . Troop registration is not complete until these forms have been submitted.

- Event volunteer positions are generally one-half day (approx. 4-6 hours). If you are willing to take on a longer position or multiple shifts, we are happy to have you! Please indicate all skills and interests on the Volunteer Information Form. Your help is truly essential and appreciated!

Descriptions of the different volunteer positions can be found on the our Jamboree webpage.